

K078LM

Macchina premonta-monta elettronica oleodinamica

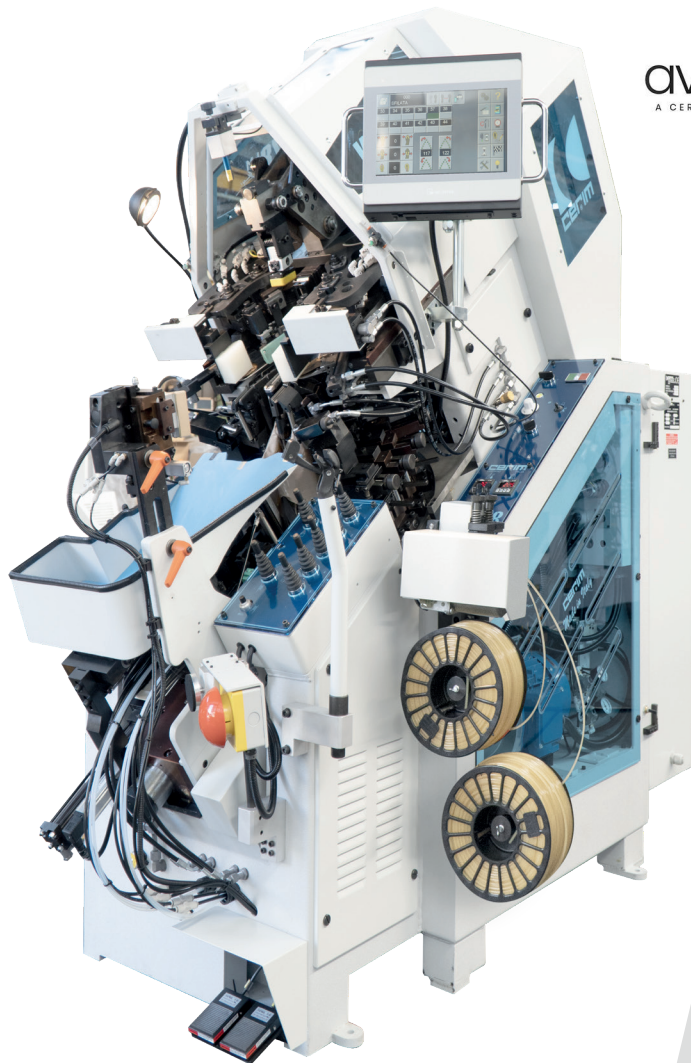

PROGRAMMABILITA' PER:

- Tempi, funzioni, tiraggi e traguardi di apertura pinze.
- Tracciatori per la totale distribuzione del collante.
- Accerchiamento pinze per il profilo forma, corsa piastre, supporto forma con posizioni intermedie e pressore posteriore.
- Movimenti di avanzamento e chiusura delle piastre di montaggio
- Pressioni di lavoro del pressore superiore con fasi di lavoro differenziate
- Velocità e posizioni del supporto forma
- Pressioni di chiusura e sfilamento pinze

SETTORI DI APPLICAZIONE



Uomo



Donna



Sportive



Sneakers Montato



Goodyear



Meno di 2 minuti per il cambio di forma nella lavorazione.



Due tracciatori mobili per la totale distribuzione del collante termoplastico su qualsiasi tipo di scarpa ed in qualsiasi misura.



Display touch screen da 10" a colori multilingua con funzioni di autodiagnostica.

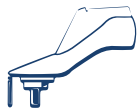

Doppio piedino di sostegno per punte sfilate e supporto forma con velocità e posizioni programmabili

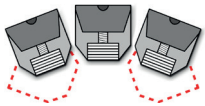

Nuovo gruppo pinze **MULTI SHAPE**: massima precisione di accerchiamento.



Sostituzione ad innesto rapido delle 3 pinze di punta.

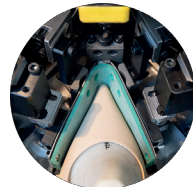

Gruppo teflon con 5 punti di spinta, sgancio rapido, pressore superiore regolabile verticale con pressioni programmate

OPTIONAL & ACCESSORI

- Sistema **CALIBRATORE MERCALLI**.
- Inclinazione piattello programmabile.
- Lavorazione per scarpe "goodyear"
- Doppio piedino di sostegno per punte sfilate
- **EASY LINK**
- Pressioni di chiusura e sfilamento pinze programmabili

K078LM

Pullingover, toe and forepart lasting machine, electronic and hydraulic

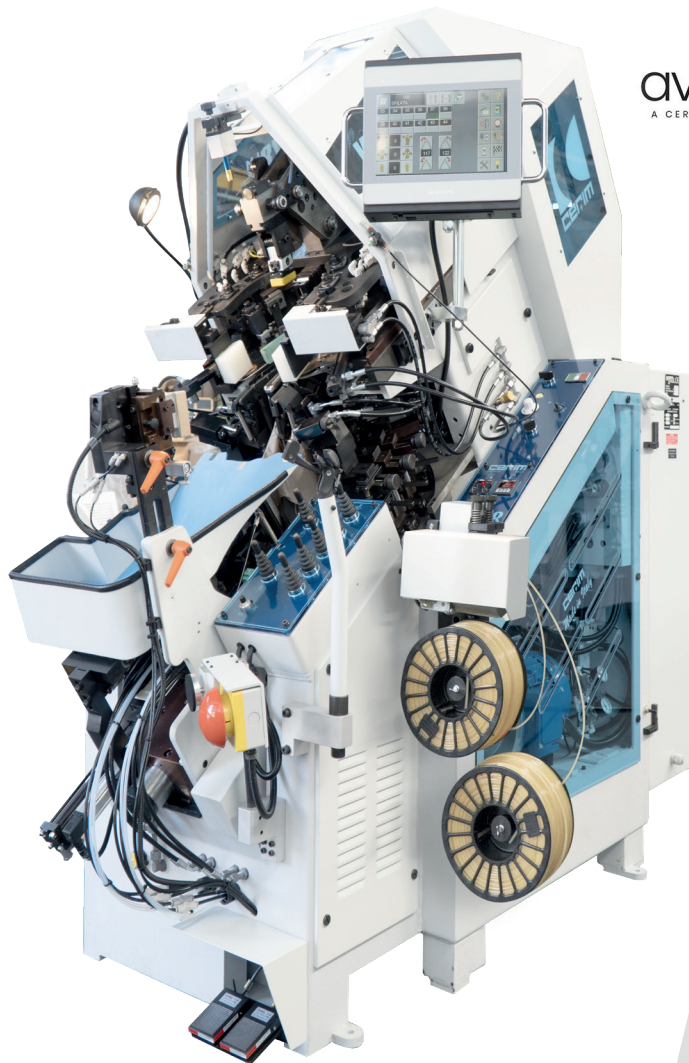

PROGRAMMABILITY FOR :

- Opening pincers times, functions, pincer's draftings and goals.
- Tracers for the whole cement distribution.
- Pincers encirclement for last profile, wipers stroke, last support with intermediate positions and heel rest.
- Forwarding and closing wipers movement
- Adjustable upper presser with different working phases
- Last support speed and positions
- Closing and slipping pincers pressures

SECTORS OF APPLICATION



Man



Woman



Sports



Lasted Sneakers



Goodyear



Less than 2 minutes for change of style.



Total thermocement application by two movable tracers suitable for any kind of shoe in any size



Full color multilanguage 10" touch screen display with fault assistant.

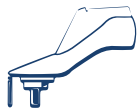

Double last support for pointed toes and programmable last support speed and positions

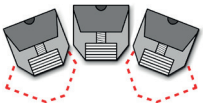

New **MULTI SHAPE** programmed pincers unit: extreme accuracy of pincers encirclement.



Quick toe pincers changing system.



Teflon with 5 pressure points, quick change, vertical upper presser with programmed pressures

OPTIONALS & ACCESSORIES

- **Mercalli Calibrator System.**
- Programmable last support inclination.
- Units for good year shoes
- Double last support for pointed toes
- **EASY LINK**
- Programmable Closing and slipping pincers pressures

CARATTERISTICHE TECNICHE

K078LM

DIMENSIONI	mm 1000 x 1900 x 1900
DIMENSIONI IMBALLO	mm 1100 x 2000 x 2100
PESO NETTO	Kg 1350
PESO LORDO IN CASSA	Kg 1570
POTENZA ELETTRICA TOTALE INSTALLATA	Kw 5,5
ALIMENTAZIONE PNEUMATICA	Bar 6

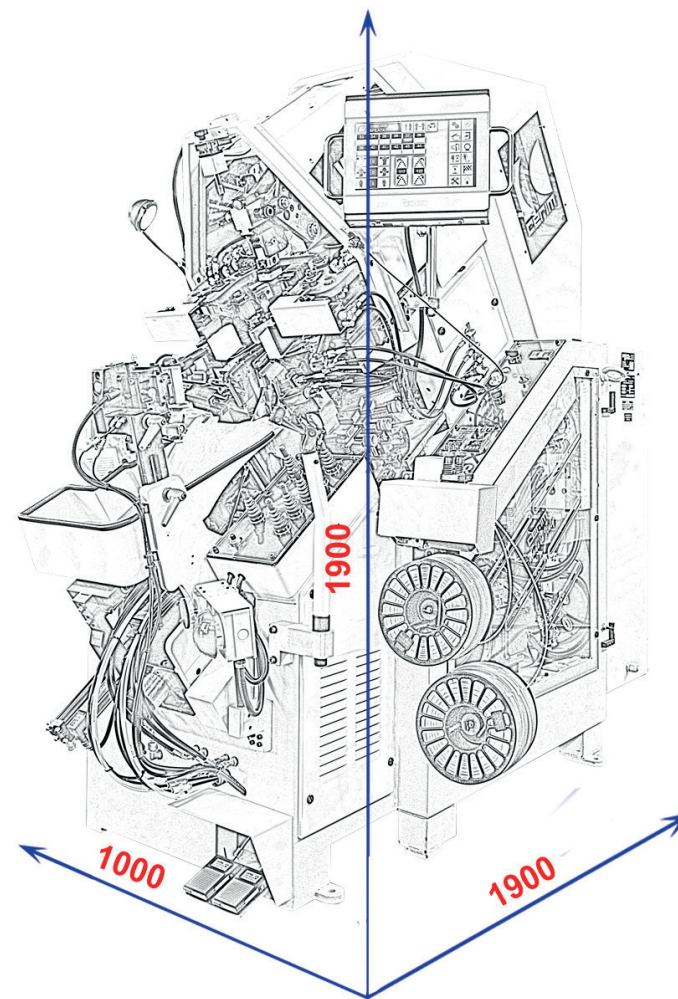

TECHNICAL FEATURES

K078LM

DIMENSIONS	mm 1000 x 1900 x 1900
PACKAGING DIMENSIONS	mm 1100 x 2000 x 2100
NET WEIGHT	Kg 1350
GROSS WEIGHT IN CASE	Kg 1570
TOTAL INSTALLED ELECTRIC POWER	Kw 5,5
PNEUMATIC POWER SUPPLY	Bar 6

